



Global Version Continuous -Wave
Laser User Guide
1000- 1500W

Wuhan Raycus Fiber Laser Technologies Co., Ltd.

TABLE OF CONTENTS

1 Safety Information	1
1.1 Security Identifier	1
1.2 Laser Safety Grade	1
1.3 Security Identifier	2
1.4 Optical Safety	3
1.5 Electrical Safety	3
1.6 Other Safety Rules	3
2 Product Description	4
2.1 Features	4
2.2 Model description	4
2.3 Package accessoriesare	5
2.4 Unpacking and Inspection	5
2.5 Operation Environment	6
2.6 Attentions.....	7
2.7 Specifications	7
Table 5 Product Specifications	8
3 Installation	10
3.1 Dimensions	10
3.1.1 Overall dimensions of Global Version 1000-1500W CW laser	10
3.2 Size and installation of output optical cable	11
3.2.1 Global Version 1000-1500W CW laser output optical cable	11
3.3 Cooling system installation and requirements	12
3.4 Installation rule	14
4 Using the Product	15
4.1 Front panel	15
4.2 Rear Panel	16
4.3 Power Connection	17
4.4 Interface definition	18
4.5 Installation Instruction	24
4.6 Start operation sequence	25
4.7 Functions of the clientware	25
4.8 Control mode selection	32
4.9 Shut down the laser:	37
4.10 Bluetooth app operation description	37
5 Common Alarms and solutions	46



5.1 Alarm display	46
5.2 Alarm processing	46
6 Warranty, Return and Maintenance	49
6.1 General Warranty	49
6.2 Limitations of Warranty	49
6.3 Service and Repair	50

1 Safety Information

Thank you for choosing Raycus fiber laser. This User Guide provides important safety, operation, warranty and other information. Please read it carefully before using this product. In order to ensure safe operation and optimal performance of the product, please follow the warnings, cautions, operating procedures and other instructions accordingly.

1.1 Security Identifier

	◆ WARNING: Describes a hazard that lead to a personal injury or death.
---	---

	◆ CAUTION: Describes a hazard that lead to a minor personal injury or product damage.
--	--

1.2 Laser Safety Grade

According to the European Community standards EN 60825 - 1, clause 9, this series of lasers are classified as a high power Class 4. This product emits invisible laser radiation at wavelength of 1080 nm, and the light power is 100 -2000W up to machine. Direct or indirect exposure of high power of laser radiation may cause damage to the eyes or skin. Despite the radiation being invisible, the beam may cause irreversible damage to the retina and cornea. Appropriate and approved laser goggles must be worn all the time during the laser device is operating.

	◆ WARNING: Users must use appropriate laser goggles when operating this device. The laser goggles is selected according to the range of wavelength emitted from this product. Users must ensure that the protect range of laser goggles over the entire range of laser wavelengths. Please do not directly view the laser output head when laser emitting.
---	---

1.3 Security Identifier

Raycus CW Fiber Lasers have different locations of safety identifier depending on the model, as shown in Figure 1:

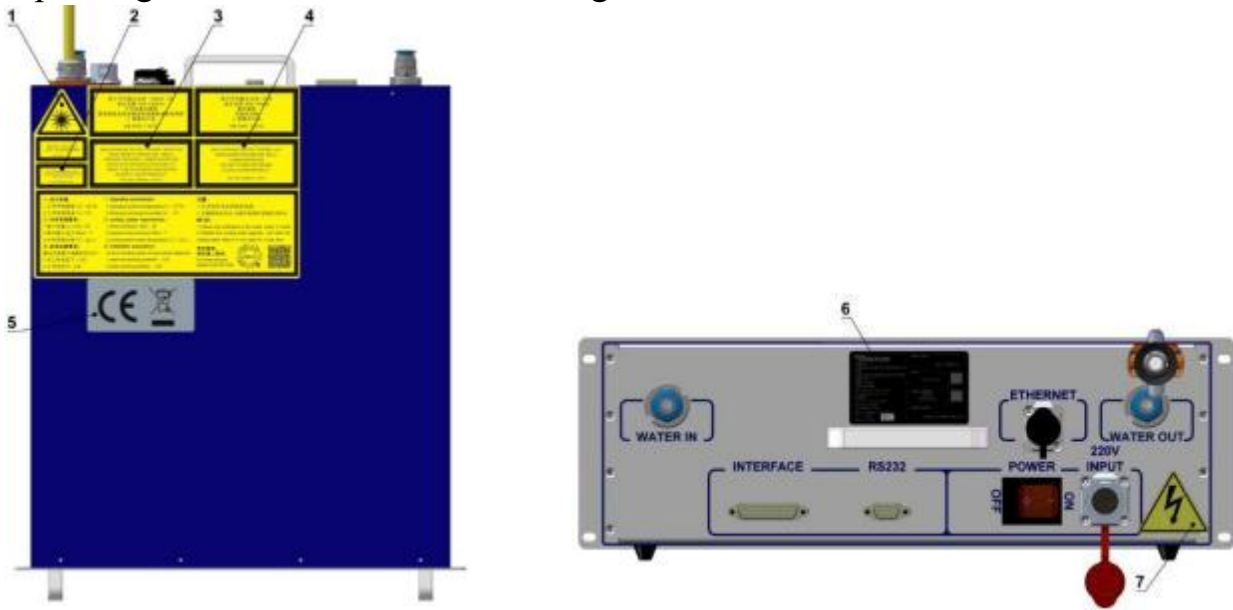

Figure 1 Laser Security Identifier

Laser safety identifier includes: safety warning, laser emit head warning, product certification, ID label, etc. The detailed descriptions of the security identifier are as follows:

Table 1 Security Identifier

1: Laser Radiation Hazard	2: Laser Emit Head	3: Type 4 Laser Product
4: Class 2M Laser Product Label- 1mW Red Laser	5: CE Authentication	
6: ID Label	7:Electrical Hazard	

1.4 Optical Safety

Any dust on the end of the collimator assembly can burn the lens.

	<p>◆ CAUTION: DO NOT emit when the protective cap is not removed, otherwise the lens or crystal will be damaged.</p>
---	---

1.5 Electrical Safety

- 1) Make sure the product is grounded through the PE line of the AC power cord.
 The grounding must be firm and reliable.

	<p>◆ WARNING: Any interruption from the protective earth will electrify the enclosure, which may result in personal injury.</p>
---	--

- 2) Make sure that the correct voltage of the DC power source is used.

	<p>◆ CAUTION: Wrong wiring mode or power supply voltage will cause an unrecoverable damage to the laser device.</p>
---	--

There are no devices that need to be used by operator in the laser. Please do not try to open the laser cover, otherwise it may cause electric shock and the warranty will be invalid accordingly.

1.6 Other Safety Rules

- 1) Do not directly view the laser output head when laser emitting. Avoid using the laser in a dark environment.
- 2) Do not use fiber lasers in dark environments.
- 3) If this device is used in a manner not specified in this document, the protection provided by the device may be impaired and the warranty will be

voided.

- 4) There are no user serviceable parts, equipment or assemblies inside the product. All service and maintenance shall be performed by Raycus. In order to prevent electric shock, please do not break the seal or uncover the shield. Failure to comply with this instruction will void the warranty.

2 Product Description

2.1 Features

Raycus fiber laser is designed for industrial and scientific research applications with high pump conversion efficiency, low power consumption and excellent beam quality. It is compact and ready to use. It can be used as a stand-alone unit or easily inserted into user's apparatus.

Main Features:

- > Excellent beam quality
- > High reliable and tightness
- > High power stability
- > Power continuously adjustable and fast switch response
- > Maintenance free operation
- > High Electro-optical Conversion Efficiency
- > Altitude Stress-resisting Capacity
- > High modulation frequency and editable waveform

Applications:

- > Welding 、 5G 、 Infrastructure
- > 3D printing
- Scientific research

2.2 Model description

Raycus continuous fiber laser includes 100, 200L, 200, 300L, 300, 500, 750, 1000 and other models, which respectively represent 100W, 170W, 200W, 250W,

300W, 500W, 750W, 1000W lasers. The definitions of the model code are shown in the table below:

Table 2 definition of model code

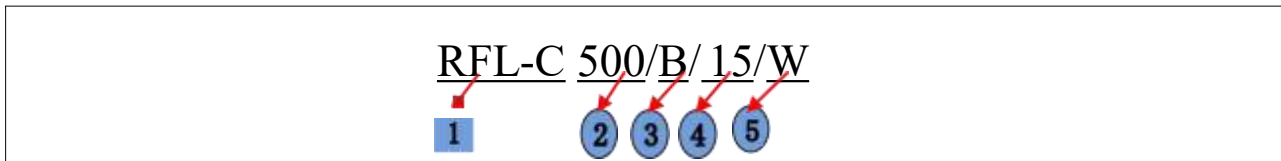

1	RFL-C series continuous fiber laser
2	Power indicator, including 100, 200L, 200, 300L, 300, 500, 750, 1000, 1500, 2000 respectively representing 100W, 170W, 200W, 250W, 300W, 500W, 750W, 1000W, 1500W, 2000W power laser
3	Wavelength, ‘B’ represents a wavelength of 1080nm
4	Output cable length, unit meter, including 10 meters and 20 meters, also can be customized length
5	Cooling method, ‘W’ stands for water cooling, ‘A’ stands for air cooling
Notes: RFL-C100 ~ RFL-C3000 laser without air conditioning	

2.3 Package accessories

Please refer to package accessories in the packing box.

2.4 Unpacking and Inspection

Raycus fiber laser is delivered in a package, which is designed to offer the maximal safety. Upon the delivery, please inspect all packaging for evidence of mishandling or damage. If you find any evidence of mishandling, please keep the damaged material and contact the shipping agent and Raycus immediately.

Please double check if each listed contents is inside the package; and contact Raycus as soon as possible if there is any issue.

Take extra care when removing the unit from the package to make the fiber optic cable stay away from collision and vibration. Please do NOT distort, bend or pull the output cable when unpacking the device; and avoid any collision to the head of laser output.

	<p>◆ CAUTION: The fiber optic cable and output head are precise optic instrument, ANY vibration or impact to the output head, and twist or excessive bend to the cable will damage the instrument.</p>
---	---

2.5 Operation Environment

The operation conditions are listed as the following table:

Table 3: The Operation Environment Conditions for the Laser

Model	RFL-C1000S-CE/RFL-C1000H-CE、 RFL-C1500S-CE/RFL-C1500H-CE
Power Source	220±10% V AC 50/60Hz
Power Capacity (kW)	4.5
Installation Environment	Flat and no vibration
Ambient Temperature ()	10 ~ 40
Relative Humidity (%)	<70

Warning:

- 1) Make sure the product is properly grounded before use.
- 2) The laser output head is connected with fiber optic cable. Please inspect the output head carefully for prevent dust or other pollution. Use appropriate lens paper to clean it if necessary.
- 3) Failure to follow the instructions when operating the laser may cause malfunction and damage.
- 4) It is not allowed to install the output head when the laser is in operation.
- 5) Do not look into the output head directly. Wear appropriate protective eye glasses all the time when operating the laser

	<p>◆ Do not expose this product to high humidity (humidity> 95%). ◆ Do not allow this product to operate at a temperature below the ambient dew point. (As shown in Table 4)</p>
---	--

Table 4 Comparison table of constant dew point at ambient temperature and relative humidity

Constant dew point table at ambient temperature and relative humidity									
Ambient temperature (°C)	Maximum relative humidity								
	20%	30%	40%	50%	60%	70%	80%	90%	95%
20	-3.5	2	6	9	12	14.5	16.5	18	19
25	0.5	6	10.5	14	16.5	19	21	23	24
30	4.6	10.5	15	18.5	21.5	24	26	28	29
35	8.5	15	19.5	23	26	28.5	31	33	34
40	13	20	24	27.5	31	33.5	36	38	39
Laser operating temperature range									

2.6 Attentions

- 1) Make sure that the correct voltage (according to Table 3) is used. Failure to connect power supply will damage the device.
- 2) Failure to operate the laser in accordance with the control or adjustment methods specified in this manual may cause damage.
- 3) The output laser is collimated by the collimating lens, it is important to keep the collimating lens clean, otherwise it will damage the device.
- 4) Please cap the output head when it is not in use. Do not touch the output lens at any time. Using appropriate lens paper to clean it if necessary.
- 5) Failure to follow the instructions may cause laser power loss, such loss is not covered by warranty.

2.7 Specifications

Table 5 Product Specifications

Model	RFL-C1000S-CE	RFL-C1500S-CE	RFL-C1000H-CE	RFL-C1500H-CE	Test Conditions
Optical Characteristics					
Output Power(W)	1000	1500	1000	1500	
Operation Mode	CW/Modulated				
Polarization State	Random				
Output Power Tunability(%)	10~100				
Emission Wavelength (nm)	1080±5				Nominal Output Power
Output Power Unstability (%)	±1.5				Nominal Output Power
					Duration: ≥5hrs;
					Ambient Temp.: 22±1°C
Modulation Frequency(Hz)	0~5,000				Nominal Output Power
Red Guide Laser Power(mW)	0.1~1				
Optical Output Characteristics of QBH head					
Beam Quality(M ²)	<1.8	2~6	/		
Beam Parameter Product (BPP)	/		BPP <1.5 mm.mrad		
Half Angle Divergence (rad)	≤0.08		≤0.06		Nominal Output Power , 4 σ Standard

Model	RFL-C1000S-CE	RFL-C1500S-CE	RFL-C1000H-CE	RFL-C1500H-CE	Test Conditions
Core Fiber(μm)	25(14、20、100、200 are optional)	50(14、20、100、200 are optional)	50(14、20、100、200 are optional)		
Delivery Cable Length(m)	20		10		Customizable length
Electrical Characteristics					
Power Supply	220±10% V AC 、 50/60Hz				
Max. Power Consumption(W)	4500				
Control Mode	RS-232/AD/Ethernet				
Other Characteristics					
Dimensions(W×H×D) (mm)	440×586×149 (include handle)				
Weight(kg)	<25				
Operating Ambient Temperature (C)	10~40				
Humidity(%)	<70				
Storage Temperature(C)	- 10~60				
Cooling Method	Water Cooling				

3 Installation

3.1 Dimensions

3.1.1 Overall dimensions of Global Version 1000-1500W CW laser

The external dimensions of the Global Version 1000 W CW laser is the same as that of Global Version 1500W CW laser. (As shown in Figure 2, take the Global Version 1500W CW laser as an example.)

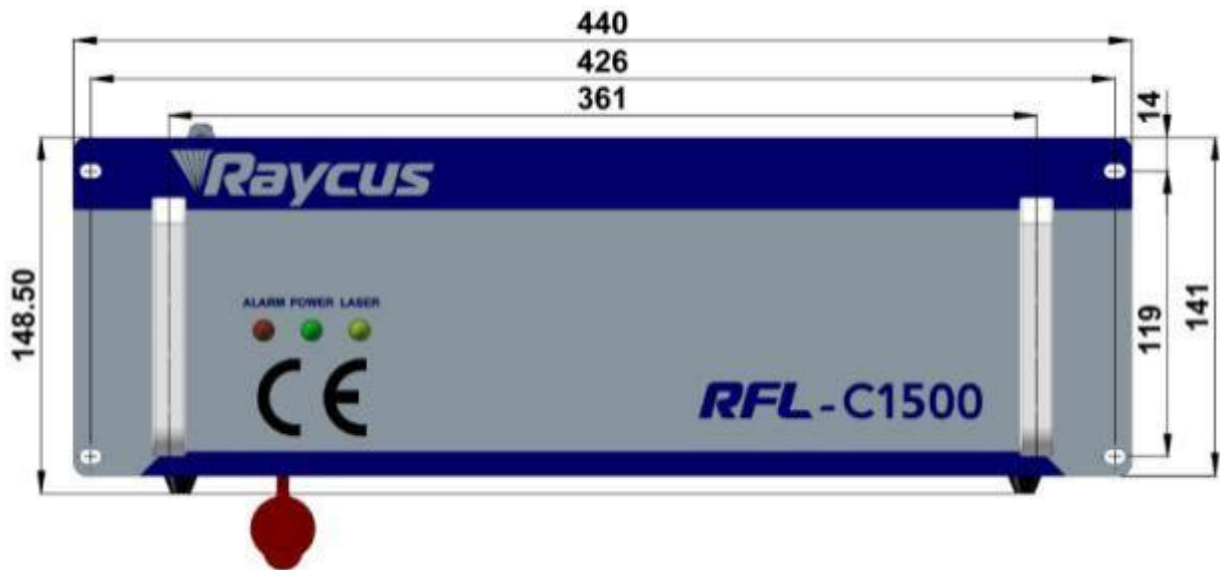

Figure 2 (a) Front view (Unit: mm)

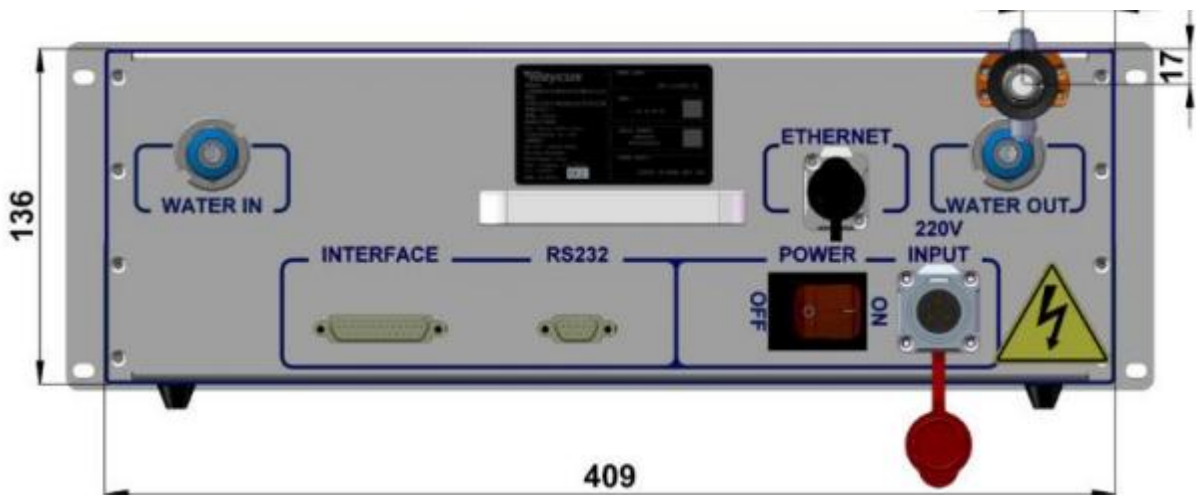

Figure 2 (b) Rear view (unit: mm)



Figure 2 (c) Top view (Unit: mm)

3.2 Size and installation of output optical cable

Raycus continuous wave fiber laser uses different laser output cables according to different laser models.

3.2.1 Global Version 1000-1500W CW laser output optical cable

The output cables of Raycus Global Version 1000- 1500W CW lasers are self-made QBH output cables. The specific appearance dimensions are shown in Figure 3 below:

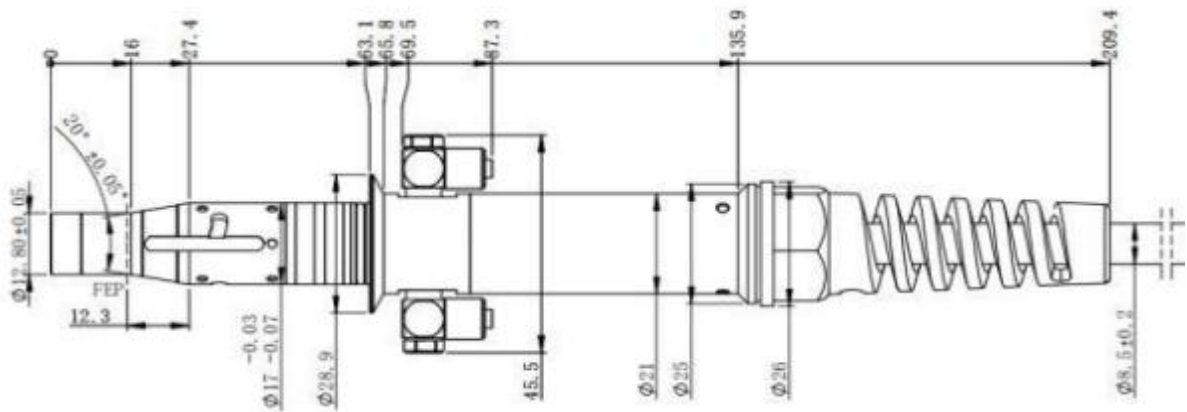

Figure 3 Dimensional drawing of handheld welding QBH output optical cable
 (Unit: mm)

	<ul style="list-style-type: none"> ◆ For QBH output optical cables, the two copper contacts (Interlock pins) on the output head must be shorted before the laser works, otherwise the laser will not work properly. Usually the copper contacts are automatically shorted after the output fiber cable is installed in the processing equipment. ◆ Before installing the output cable in the processing head, the lens of the output cable must be inspected. If the lens is dirty, it must be cleaned. ◆ It is forbidden to disassemble the output lens by anyone other than Raycus, otherwise the warranty will be invalidated
--	---

3.3 Cooling system installation and requirements

Table 6 Cooling Requirements

Model	RFL-C1000S-CE/RFL-C1000H-CE、RFL-C1500S-CE/RFL-C1500H-CE
Cooling Capability (W)	>4500
Minimum Flow (L/min)	16
Maximum Pressure (Bar)	7
External diameter of water-cooling pipe (mm)	12
Cooling system water temperature (C)	$22 \pm 1C$

1) Temperature setting of cooling water:

- > $22\pm 1^{\circ}\text{C}$ (It does not have to be changed in summer).

2) Requirements on Cooling Water:

- Purified water should be used.
- > In order to prevent the growth of mold that may lead to blockage, adding alcohol solution to about 10% of the total volume is recommended.
- > If ambient temperature is between -10°C and 0°C , we recommend to use 30% alcohol(volume ratio), and replace it every 2 months.
- > If ambient temperature is below -10°C , the chiller with both heating and cooling functions must be used, and keep it in full-time operation.

3) Other cooling system requirements:

- > Check the entire water system and joints for leaks, the first time starting the cooling system. The external water pipe must be installed and connected according to the water inlet (IN) and water outlet (OUT) indicated by the laser, otherwise the laser may not work properly.
- > If the laser is not used for a long time, the cooling system and the cooling water inside the laser should be drained, otherwise it will cause irrecoverable damage to the laser.

	<p>◆ Set the water temperature of the cooling system correctly according to the ambient temperature. If the water temperature is set too high, the laser will not work properly. If the water temperature is set too low, condensation will occur inside the laser or the laser output cable, which will cause irrecoverable damage to the laser</p>
---	--



	<p>◆ Before starting the laser, the cooling system must work properly and the water temperature reaches a suitable temperature.</p>
---	---

3.4 Installation rule

- 1) Place the product in an appropriate position, immobilize it if necessary.
- 2) Check if the power supply has the correct voltage (laser model and power voltage refers to product parameters in Table 5), and the earth line is connected, make sure it is firm and reliable
- 3) Connect the power cable and control cable to the product when power supply is OFF.
- 4) Connect the cooling system to the laser and output fiber cables according to the water inlet and outlet signs.
- 5) Please check the laser output head and do the necessary cleaning before installing it in the device. If you find that there is dust or foreign objects that cannot be cleaned, please contact Raycus in time, and do not continue installation and operation for the time being.
- 6) Prevent the delivery cable from treading, pinching or excessive bending during installation.
- 7) Please handle the laser output cable carefully, and do not receive vibration during the installation and disassembly.
- 8) Make sure the environment is clean, or the output head may be contaminated. It is prohibited to use fan during installation, which will cause dust in the air.
- 9) The minimum bending diameter of the transmission cable of the laser shall not be less than 20cm in the non-working state (such as transport and storage). The minimum bending diameter should not be less than 30cm when the laser is work.



◆ CAUTION: All the cables can only be connected when power supply is off. Hot plug may damage the device.

	<ul style="list-style-type: none">◆ Ensure that there are no fiber bends in radius less than 30cm when the product is installed. Avoid excessive twisting and tight bends during the robotic arm movements.◆ Tight bends will damage the laser delivery system.
	<ul style="list-style-type: none">◆ Before the laser output cable is assembled, the lens and the cutting head cavity must be clean and free of pollution.◆ Keep the protective cap properly, prevent it from contamination; or the aperture will be contaminated when capped.

4 Using the Product



The Raycus continuous fiber laser (with network port) has stopped using the super terminal. After the laser is powered on, there is no display on the super terminal. Please log in to the official website of Raycus to download the new version of the upper computer software and upper computer software instruction manual.

Web: <http://www.raycuslaser.com/index.php/index-show-tid-53.html>

4.1 Front panel

Figure 4 shows the front panel style of Global Version 1000- 1500W CW laser (take the Global Version 1500W CW laser as an example):

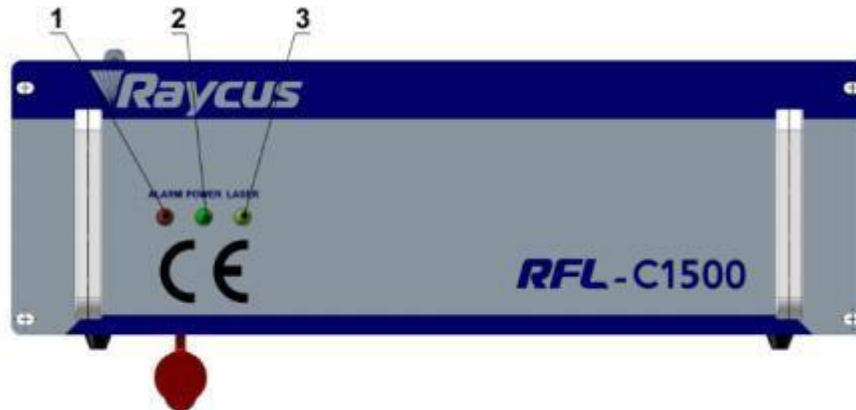

Figure 4 Global Version 1000- 1500W laser front panel

4.2 Rear Panel

Figure 5 shows the rear panel style of Global Version 1000- 1500W CW laser:

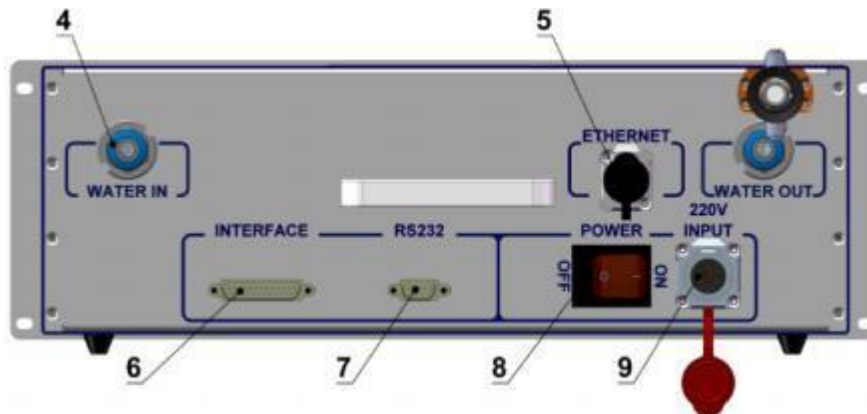

Figure 5 Global Version 1000- 1500W laser rear panel

1. **Alarm:** Laser fault indicator.
2. **Laser:** Laser output indicator.
3. **Power:** Power indicator, indicates that the power is switched on when the LED illuminates.
4. **Water pipe joint:** Quick connector, insert the quick-plug water pipe with an outer diameter of 12 into the quick –insert connector for cooling the circulating cooling water.
5. **ETHERNET:** Ethernet interface for communication between laser and upper computer.
- 6 **Interface:** Laser external control interface, see [4.4 Interface and Definition]

7. **RS232:** 232 serial interface for communication between laser and host computer.
8. **Power:** Rocker switch for turning on the laser's main power.
9. **220V INPUT:** 220V power line input.

4.3 Power Connection



	<p>◆ Before connecting the AC power supply, please check whether the laser model and the AC power supply provided are consistent with those listed in Table 3 or table 5.</p>
---	---

Table 7 Power connection requirements

Model	RFL-C1000S-CE/RFL-C1000H-CE 、 RFL-C1500S-CE/RFL-C1500H-CE
Power supply	220±10% V AC 50/60Hz
Power cord	 
Power cord end	Three strands, marked L, N and PE respectively
Label description	L->Phase line (brown) N ->Neutral (blue) PE->Protective earth wire (yellow green)

Note	Insert the plug at the end of the power cord into the socket marked "220V INPUT" on the rear panel. Note that the plug has anti-reverse connection function. After plugging it in, lock it with a lock.
------	---

4.4 Interface definition

4.4.1 Control interface

Figure 6 shows the DB25 control interface diagram:

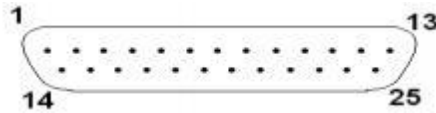



Figure 6 DB25 control interface

The pin definitions of DB25 are as follows:

Table 8 Control interface definition

PIN	Name	Input and output	Function	Typical	Min	MAX	Electric current
1	Interlock2-	/	No contact point, external voltage or grounding is not allowed (PINS 1 and 4 need to be short-circuited before the laser output)	Short circuit	/	/	/
2	Interlock1-	/	No contact point, external voltage or grounding is not allowed (these two PINS need to be short-circuited before the laser output)	Short circuit	/	/	/
3	Interlock1+	/			/	/	/
4	Interlock2+	/	No contact point, external voltage or grounding is not allowed (PINS 1 and 4 need to be short-circuited before the laser output)	Short circuit	/	/	/
8	RPA	/	External voltage or grounding is not allowed (PINS 8 and 9 need to be short-circuited before the laser output)	Short circuit	/	/	/
9	RPB	/			/	/	/
10	PWA	/	External voltage or grounding is not allowed (PINS 10 and 11 need to be short-circuited before the laser output)	Short circuit	/	/	/
11	PWB	/			/	/	/
12	Analog	Analog input	External analog quantity setting	0- 10V	0V (0%)	10V (100%)	<10mA
13	Laser Power	Analog output	Optical power signal output	/	0V (0%)	8V (100%)	>5mA
14	AGND	Analog ground	12, 13 feet return	0V	/	/	/
15	MOD+	Digital input	Laser modulation signal	16-24V	16V	24V	<10mA
16	MOD-	Return	15 feet return	0V	/	/	/
17	Red Laser	Digital input	Red light control	16-24V	16V	24V	<10mA
18	Laser EN	Digital input	Laser enable	16-24V	16V	24V	<10mA

PIN	Name	Input and output	Function	Typical	Min	MAX	Electric current
19	Ready	Digital output	Laser ready	24V	/	/	>10mA
20	DGND	Digital ground	17/18/19/21/22/23/24 common grounds	0V	/	/	/
21	EX_RST	Digital input	Laser fault reset	16-24V	16V	24V	<10mA
22	Laser Error	Digital output	Laser fault output signal	24V	/	/	>10mA
23	POWER	Digital output	High level=Main power supply started	24V		24V	>10mA
24	LASER	Digital output	High level=Laser is emitting	24V		24V	>10mA
other	N/C	/	Not allowed to connect	/	/	/	/

	<ul style="list-style-type: none"> ◆ Please check the level of the control signal to ensure compliance. Exceeding voltage or voltage fluctuations may damage the laser ◆ Please ensure that the analog signal DOES NOT exceed 10V, or product may be damaged. ◆ The Interlock interface is PIN 1 and PIN 4 、 PIN 2 and PIN 3 of DB25. If these two pins are disconnected, the laser will immediately interrupt the light, the laser Ready signal output will become low level, and the laser will display an Interlock alarm. ◆ The Interlock interface shall not be connected with active signal, otherwise it will cause interface damage and laser alarm. ◆ Before powering on the laser, please make sure that PINS 8 and 9 、 PINS 10 and 11 are short-circuited, otherwise the laser cannot be powered on.
---	--

4.4.2 RS-232 serial port

The following figure shows the RS-232 serial port

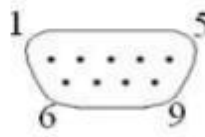

Figure 7 RS232 serial port

Each pin is defined as follows.

Table 9 RS-232 serial port definition

PIN Number	Definition
2	RX
3	TX
5	GND
others	N/C

A three-core (RxD, TxD, GND) interface is used. For specific commands and descriptions, please refer to the software manual of the host computer or ask a Raycus technician for a communication protocol. The specific parameter settings of the RS-232 control interface are as follows:

Table 10 RS-232 interface configuration parameters

Parameters	Set up
Baud rate	9,600
Data bits	8
Stop bit	1
polarity	None
Flow control	None

Figure 8 RS-232 serial cable configured for the product:



Figure 8 RS-232 serial cable

4.4.3 Ethernet TCP / IP interface and connection steps

The default IP address of the laser is 192.168.0.10 and the laser only supports UDP communication. The laser listens for connections on port 8099. The command must be sent as a single string in a single packet.

Table 11 Ethernet interface pin definition

PIN	Description	Notes
1	TX+	Transmit Data+
2	TX-	Transmit Data-
3	RX+	Receive Data+
4	N/C	Not Connected
5	N/C	Not Connected
6	RX-	Receive Data -
7	N/C	Not Connected
8	N/C	Not Connected

If conditions permit, please use this interface first to get better communication stability.

Ethernet connection steps:

Default IP address of the laser	
IP address	192.168.0.10
Subnet Mask	255.255.255.0

IP Configuration:

Step 1: Open "Local Area Connection" on your computer and click "Properties";

Step 2: Select "Internet" protocol version 4 (TCP/IP4);

Step 3: Click the "Properties" button;

Step 4: Select "Use the following IP address:" to manually assign IP addresses;

Step 5: Assign the IP address 192.168.0.x (x cannot be 10 because 192.168.0.10 has been assigned to the laser), and then assign the subnet mask address, which is 255.255.255.0 by default;

Step 6: Click "OK" to confirm the setting and exit. See Figure 9 for details.

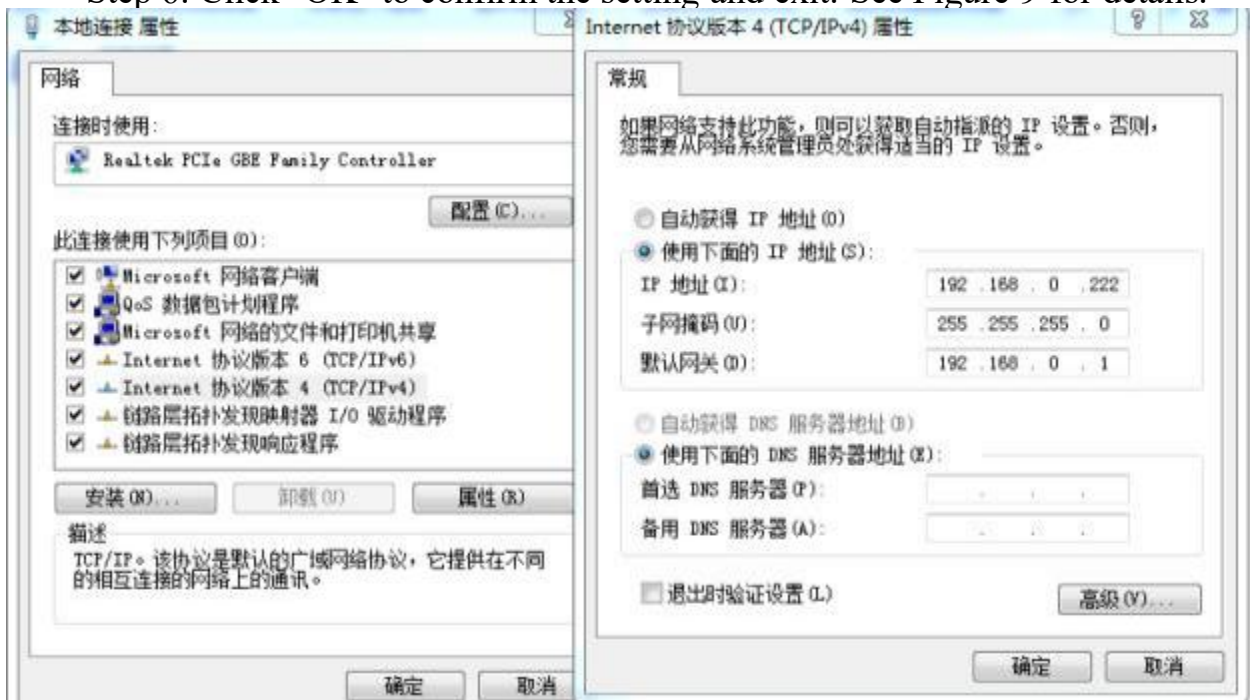

Figure 9 IP settings on the PC terminal

After the IP setting is completed, open the upper computer, and the connection status in the corresponding text box on the upper computer interface shows that it is connected, indicating that the SCM program is running normally and the communication connection is normal. The display interface is shown in Figure 10:



Figure 10 Main interface of normal communication connection display

4.5 Installation Instruction

- 1) Take out the laser carefully, move it to the installation position, fix the laser with screws through the installation holes on the front panel of the machine.
- 2) Remove the protection cap of the output head, use strong light to check if there is dust on the lens of the output end. If so, please clean it before use, and then cover the protection cap of the output head.
- 3) Install the output optical cable on the processing equipment according to the actual situation (also install the output head cooling water pipe), pay attention to arrange the output optical cable, and protect the output head. After installing and arranging the output optical cable, remove the protective cap, and check whether the output lens is clean again, and then install the output head;
- 4) Remove the rubber pipe plug and safety clip at the quick connect joint of the inlet and outlet, connect the laser cooling water pipe, and then install the safety clip back;

- 5) Connect the control line and power supply according to the control mode.

4.6 Start operation sequence

Make sure the air switch is off. All electrical connections must be completed before the laser is powered on.

- 1) Turn on the chiller and check the water pipe for leaks. If there is no leakage, turn off the chiller and wait for the laser to turn on;
- 2) Ensure that PIN 1 and PIN 4, PIN 2 and PIN 3 Interlock on DB25 PINS have been short-circuited and closed; Ensure that the remote power-on switch of PIN 8 and PIN 9 have been short-circuited and closed; Ensure that PIN 10 and PIN 11 emergency stop switches have been short-circuited and closed;
- 3) Close the air switch on the rear panel and wait for the laser to power on and perform a self-test.

Note: When the working environment temperature and relative humidity are within the dew point area (blue) in Table 4, for RFL-C100 to C3000 type lasers, please improve the working environment of the laser to avoid damage to the laser due to condensation.

4.7 Functions of the clientware

The clientware of the Global Version 1000- 1500W CW laser is communicates with the main control board through UDP when it is working. Through the background program running in the software and the human-computer interaction operation, the laser parameters are read and set and the control functions are realized. The interface displayed by the software is divided according to functional categories, including control, alarm, about, language selection, authorization, working mode selection and other pages.



Figure 11 The clientware interface

4.7.1 The control interface

The control interface is the content displayed on the first page after opening the clientware, including the user's most commonly used status signal, laser parameter setting and laser control related functions.

Control abnormal laser reset: Click the reset button to run the abnormal laser reset command.

Guide laser: the guide laser is turned on or off in the internal control state of guide laser. After the guide laser is turned on or off, there will be changes in the guide laser state on the software.

Guide laser external control: turn on the guide laser external control or turn off the guide laser external control. After turning on and turn off the guide laser external control, there will be changes of the guide laser external control state in the software. If the current red external control state, then disable the red control button.

Control laser parameters: Optical output parameters include power, frequency, pulse width, and duty cycle. The communication between the software and the

main control board requires only power, frequency, and pulse width. The duty cycle can be calculated from the pulse width and frequency, and the pulse width can also be calculated from the duty cycle and frequency. During the software operation, the frequency and duty cycle will be changed synchronously with the pulse width, and the duty cycle will also be changed synchronously with the frequency and duty cycle. The output power can be an integer in the range of [0, 100]. The frequency can be set to a decimal in the range of [0, 5000]. The duty cycle can be set to a decimal in the range of [0, 100].

Control light emission mode: light emission related modes include AD mode, external enable, external modulation mode, and internal modulation mode. You can individually control the opening and closing of each mode, and display the current status of each mode. After the AD mode is turned on, the optical power is controlled by an external signal, and the power setting function of the software should be set to a disabled state. When the external modulation mode is turned on, the frequency, pulse width and duty cycle are controlled by the external modulation signal, and the function of the software to set the frequency, pulse width and duty cycle should be set to the disabled state.

Control the light: control to turn on or off the laser emission or laser enable. Only when the laser has a ready signal, can it be controlled normally, otherwise the buttons for turning on and off the laser are set to the disabled state. When the external control light enable is turned off, and the external modulation mode or internal modulation mode is turned on, the "laser enable" is displayed, otherwise, the "laser emission" is displayed.

Status display: Including emergency stop, laser enable, Interlock logic normal, Interlock1 closed, Interlock2 closed, power ramp up and down, program mode, program execution, program execution completed, program execution abnormal and other most commonly used laser states, and machine Internal ambient temperature, internal ambient humidity, dew point, external 0- 10V, light output

frequency, light output duty cycle, light pulse width, laser water flow, output optical cable water flow and other data. These status and data refresh time intervals should not exceed 300ms.

Laser usage time display: including today's turn-on time, today's light-emitting time, cumulative turn-on time, and cumulative light-emitting time.

4.7.2 The alarm interface

All the alarm information of the current laser is displayed on the alarm interface, and the alarm information is updated in real time.



Figure 12 The alarm interface

4.7.3 About

The laser time, model, serial number, master control serial number, key version number and system information are displayed in the interface , when the about interface is opened, the upper computer software reads them from the master control module once.



Figure 13 The about interface

4.7.4 Language Selection

In the language selection interface, you can set the language used by the software. After selecting the language and clicking OK, you do not need to restart the software, automatically convert the content displayed in the software into a language, save the currently selected language to the configuration file, and display it according to the last set language when starting the software next time.



Figure 14 Language selection interface

4.7.5 Authorization

The authorization interface is used to control the limited time lock of the laser, when the authorization interface is opened, the machine code, laser lock time and lock time are loaded once, the laser lock time is Raycus' limited time lock for integrators, and the lock time is for the integrator to end customers. Limited time lock. In the authorization interface, only Raycus' authorization code can be set, and

the function of calculating the authorization code is implemented in the server and has nothing to do with the host computer software. The authorization code used by the integrator can be generated in the authorization interface.



Figure 15 Authorization interface

4.7.6 The Mode Selection function

Select the operating mode of the software, including monitor mode, control mode, diagnostic mode, and debug mode.

Monitor mode: **The monitor mode is selected by default when the software is opened.** The most commonly used and concerned information is displayed on the software interface to avoid the interference of too much information to the user. The monitor mode can be used without password.

Control mode: The control mode adds the function of the operable control interface on the basis of the observation mode, and the password is required to enter the control mode.

Debug mode: On the basis of diagnostic mode, the parameter setting interface is added. Only Raycus debug engineers can enter the encryption mode.

Diagnostic mode: When a laser fails to diagnose remote after -sales, or the integrated dealer needs to understand more status information of the laser, you can enter the diagnostic mode.

4.7.7 Main control module

The main control module contains all states, alarms and system parameters of the main control module. The status and alarm information are automatically refreshed. Only when the currently selected page is in the main control module, the upper machine software will automatically read and refresh status and alarm information. Reducing the frequency of communication and avoid too many resources to occupy the main control module.



Figure 16 Main control module status information interface

4.7.8 Slave control module

Power surveillance contains the alarm of the ACDC module and DCDC module. The monitoring enables the control, the failure level is high, the low level is set, the level is high, low settings, and the CAN communication enables the settings. (The power supply schemes of different models are different, and the opening level and fault level modes are different. Please refer to the actual model.

The following power supply monitoring module interface is only for display, not for parameter guidance.)



Figure 17 Slave control module status information interface

4.8 Control mode selection

4.8.1 Control mode wiring diagram

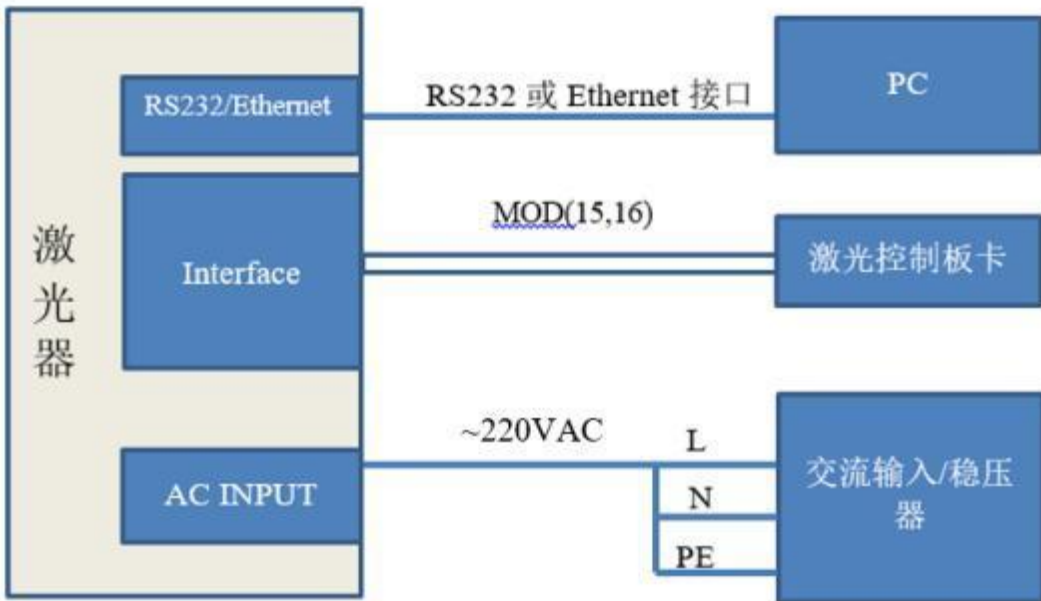

Figure 18 Wiring diagram in RS-232 mode

Note: The above modes need to be modified by using the Raycus upper computer, turn off the red light external control, enable the external light output and external AD, and only retain the modulation mode.

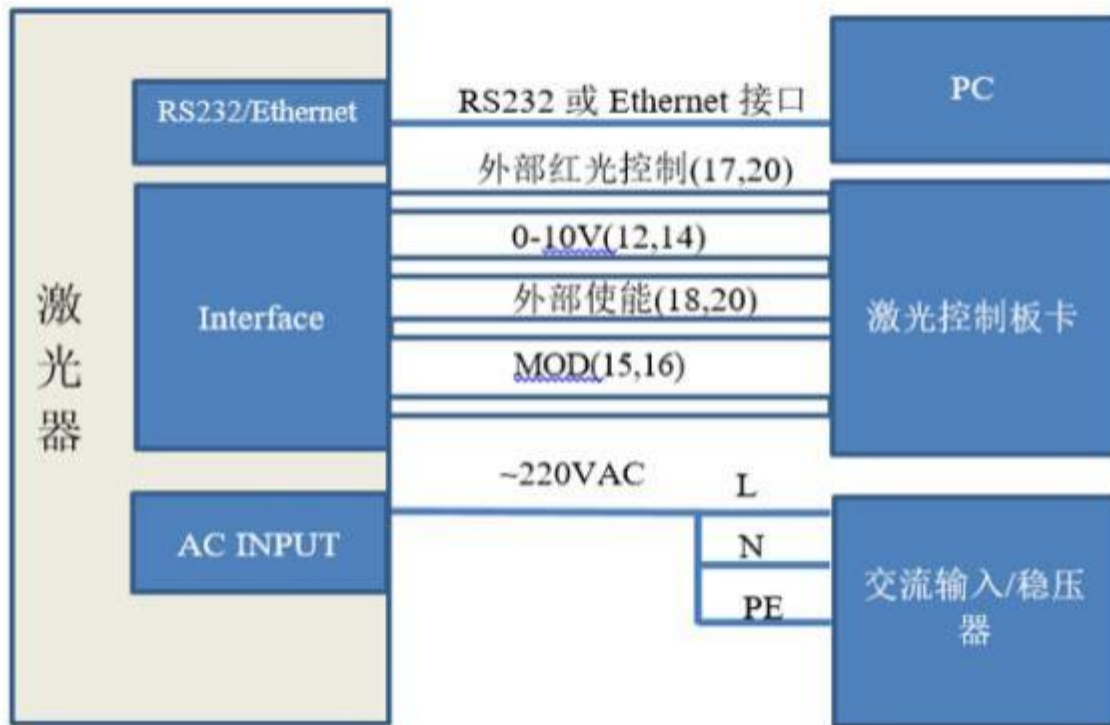

Figure 19 Wiring diagram in AD mode

4.8.2 Stand-alone mode (internal control mode) (connect 4.6 in sequence)

- 1) Turn on the air switch and the panel "power" indicator light is on;
- 2) Wait for 20s, internal main control board circuit initialization is completed;
- 3) Turn off all the external control modes of the laser (turn off the red light external control, external light output enable, external AD and modulation mode);
- 4) Set the power of the laser (the laser power is to be set by 0- 10V analog quantity, when the AD mode is on; and to be set by the serial port or Ethernet, when the AD mode is off);
- 5) Turn on the laser enable;

- 6) The serial port or the Ethernet interface sends a shutter opening command to output the laser, and sends a shutter closing command to turn off the laser.

Shutdown the laser, please refer to [4.9 Closing operation sequence].

4.8.3 External control mode (sequentially connected to 4.6)

Modulation: When the duty cycle of the laser's internal frequency is set to 100%, the laser works in external modulation mode. The on and off of the laser is controlled by the "modulation" signal provided by the user from the external MOD interface. For the timing diagram, see [4.8.5 Control timing Figure];

Gate mode : When the duty cycle of the internal frequency of the laser is set to less than 100%, the laser works in internal modulation mode. The laser is turned on and off by the user from the external MOD signal and internal frequency generator. Stop internal pulse generation, see [4.8.5 Control Timing Diagram] for timing diagram;

The laser works in external modulation mode by default after power on.

- 1) Turn on the air switch and the panel "power" indicator light is on;
- 2) Wait for 20s, internal main control board circuit initialization is completed;
- 3) Set laser power (laser power is set by 0- 10V analog when AD mode is enabled, laser power is set by serial port or Ethernet when AD mode is off);
- 4) Send a light enable signal to the laser in one of the following ways
 - Interface gives light enabling signal (connect 24V between PIN 18 and PIN 20)

- Serial port or Ethernet interface to issue the shutter open command-enable light

5) The On/Off of the laser is controlled by the "modulation" signal provided by the external mod interface;

Shutdown the laser, please refer to [4.9 Closing operation sequence].

4.8.4 AD Mode

The laser enters the external AD mode through the upper computer selection. The laser power is controlled by the voltage between pin12- 14 of DB25 control interface (0V-0% power, 10V- 100% power).

If the upper computer selects external AD mode off, the laser power is set by serial port or Ethernet, and the Raycus laser will enter external ad mode by default when powered on.

4.8.5 Controlling time-series chart

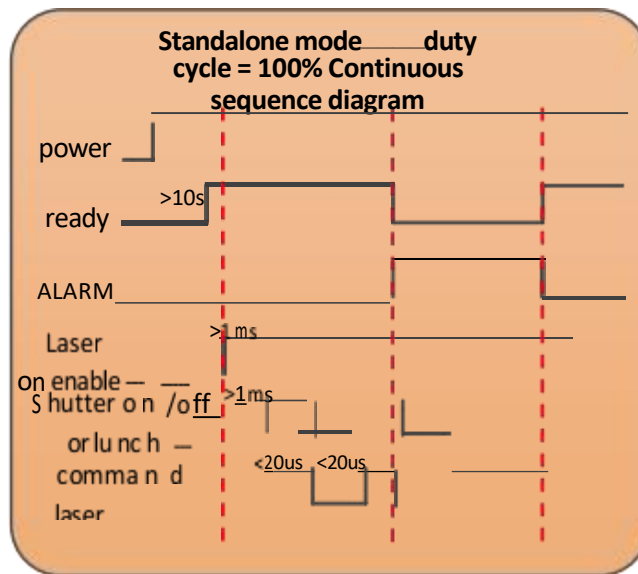

Figure 20 Standalone mode – Continuous sequence diagram

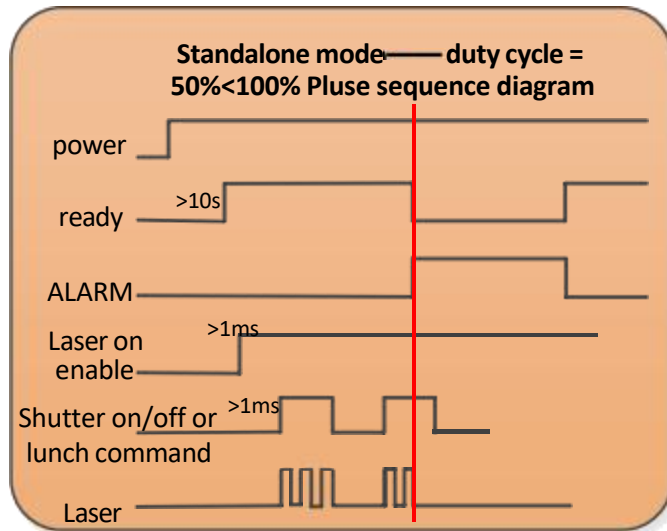

Figure 21 Standalone mode – Pulse sequence diagram

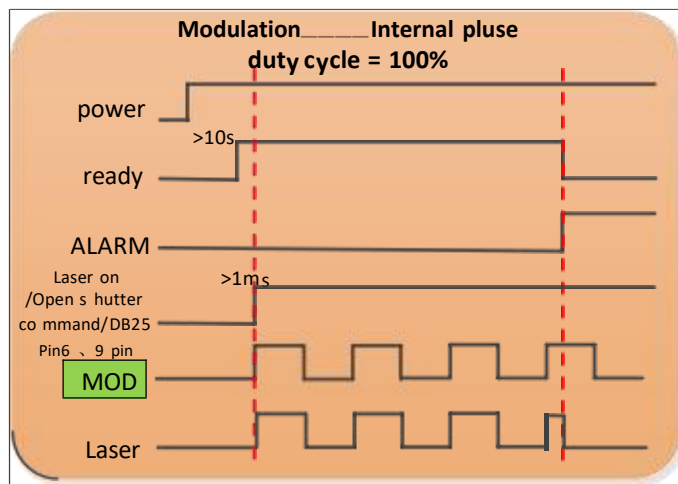

Figure 22 Modulation – sequence diagram

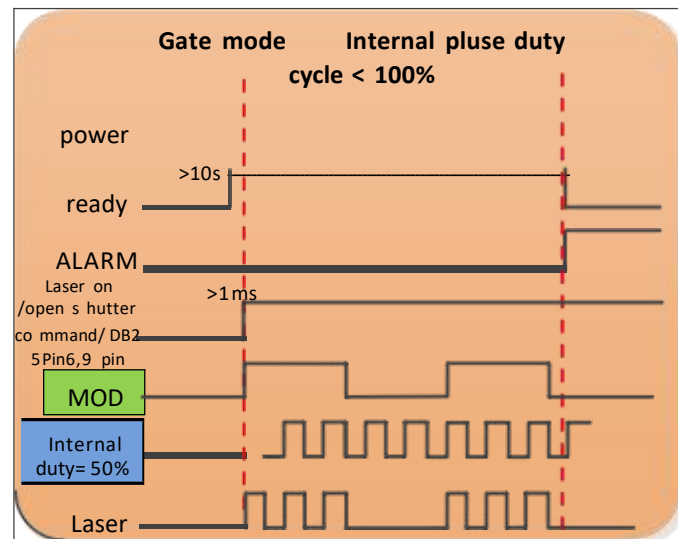



Figure 23 Gate mode – sequence diagram

4.8.6 Red Light Control

Turn on the air switch, wait for 20 s, the laser enters the red-light external control mode, and a high level of 5-20V is given before the 17-20 feet. If red light internal control is selected on the host computer, you can use the host computer to click "red light on" to turn on the red light.

	◆ Laser and red indicator light can be output simultaneously
---	---

4.9 Shut down the laser:

Please turn off the laser in the following sequence:

- 1) Turn off the laser output enable;
- 2) Turn off the air switch;
- 3) Turn off the chiller;
- 4) If the laser is not equipped with air conditioner, please ignore this step; If it is equipped, please wait for the air conditioner to continue working for 10min;
- 5) Put on the output head protection cap.

4.10 Bluetooth app operation description

4.10.1 Log in

After opening the single - mode laser app, there is an account password login page, as shown in Figure 24:



Figure 24 login interface

4.10.2 Connect

After entering the login interface, enter the mobile phone number and password, and then click the login. After the login is successful, enter the APP connection page, as shown in Figure 25:



Figure 25 Verification code login interface

Open the Bluetooth switch of the single -mode laser app. If there is a Bluetooth device nearby, ensure that the switch of the Bluetooth device is turned on and click the "Search" button on the connection page.



Figure 26 connect

Click the "Connection" on the right side of the searched Bluetooth device to enter the connection state, as shown in Figure 27:



Figure 27 connecting

4.10.3 Equipment

After the connection is successful, enter the laser device-status interface, as shown in Figure 28:



Figure 28 device status

The device status page mainly includes the main power supply, equipment, alarm, and light state display, as well as the state of light percentage, light power, laser temperature status, and the state of emergency stop, REM, laser enable, red light display, and laser device, and laser The specific state and some parameter values are displayed.

There is also a device-alarm page, as shown in Figure 29:

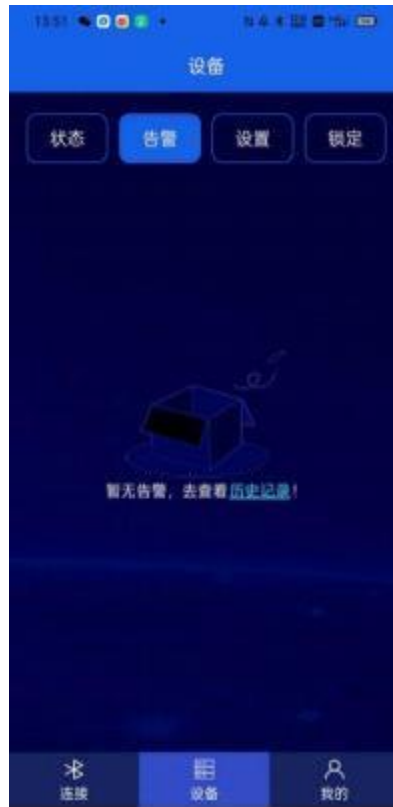

Figure 29 Equipment-alarm

If the device alarm page is connected to the laser, the laser is not alarm, and the interface will display "No alarm, check the historical records!", If there is a alarm state, the specific title of the alarm will be displayed.

The state display of the laser also has the setting function that supports some parameters. It can be visible in the device-settings interface, as shown in Figure 30:



Figure 30 Equipment-Settings

In the device-lock interface, the laser can be locked or unlocked to the laser through the device authorization code. The specific form of the page is shown in Figure 31:



Figure 31 Equipment-Lock

4.10.4 My page

Entering my page, you can see function introduction, version update, and about machines, as shown in Figure 32.



Figure 32 page

The function introduction interface is a specific introduction to the laser. As shown in Figure 33:



Figure 33 Features

The version update interface is the content of the current version of the laser and the content of the upgraded version. As shown in Figure 34:



Figure 34 New version update

Mine - About the machine page shows the relevant information of the laser, such as laser time, laser model, laser serial number, main control serial number, key version number, system information. As shown in Figure 35:



Figure 35 Mine-About the machine

In Mine - About machine - System Information page, and laser detailed information. As shown in Figure 36:

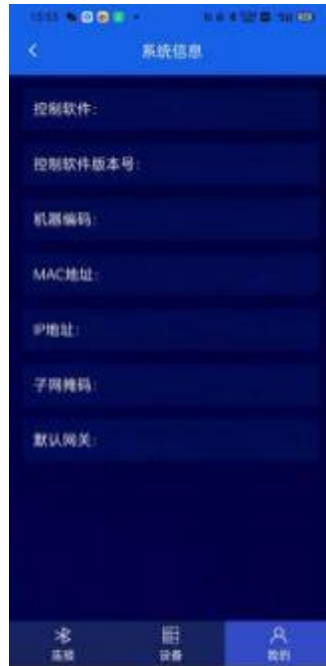
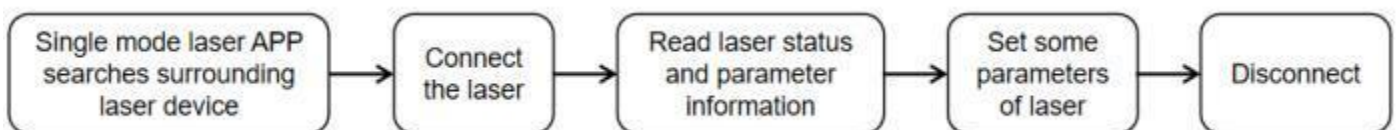

Figure 36 Mine - About Machine - System Information

4.10.5 Software introduction

The single -mode laser app is a mobile software that can be connected to the laser through Bluetooth to facilitate the after -sales, maintenance, and commissioning engineers, etc., without portable notebooks, you can use the single -mode laser app installed on Android phones to and the laser. Connect, read the state of the laser or set some parameters, which is conducive to the rapid, effective and convenient solution to some problems in the use of laser use.

4.10.6 Workflow



5 Common Alarms and solutions

5.1 Alarm display

Connect the computer and open the PC software (*download the PC software and its instruction manual, please log on the Raycus official website*), after the laser and client software establish normal communication. All laser alarm states can be displayed on the client software interface, as shown in Figure 38. The laser will give an alarm in the case of abnormal internal temperature, abnormal output power, abnormal power supply, abnormal condensation, etc.



Figure 38 Main interface of upper computer software

When the laser is running and any alarm occurs (except for the abnormal Interlock), the upper computer software interface will also display the alarm. At the same time, the alarm light (yellow) on the laser panel will be on, and the laser will stop and lock.

5.2 Alarm processing

The instructions and possible solutions of alarms are as follows:

Table 12 Error instructions and possible solutions

Alarm message	Error instructions and possible solutions
System Timer Alarm	<p>Instruction: Internal clock abnormal.</p> <p>Solutions: When this alarm occurs, please contact Raycus directly.</p>
Laser On Button Alarm	<p>Instruction: This alarm occurs when the light exit button on the front panel of the laser has been pressed before powering on.</p> <p>Solutions: When this alarm occurs, please power off the laser and make the light enable button pop up, and then power on the laser again to cancel the alarm. If the alarm continues to occur, please contact Raycus.</p>
Inter Lock Alarm	<p>Instruction: Occurs when the laser Interlock is disconnected.</p> <p>Solutions: Short the Interlock pins. If this error continues to occur, please contact Raycus.</p>
Current Driver Alarm	<p>Instruction: Internal constant current driver is error.</p> <p>Solutions: Restart the Device. If this error continues to occur, please contact Raycus.</p>
Laser Out Alarm	<p>Instruction: The laser will get this alarm when it can not detect any laser light signal. Laser out alarm occurs only when the laser is emitting light</p> <p>Solutions: Restart the Device. If this error continues to occur, please contact Raycus.</p>
Laser Power Alarm	<p>Instruction: The alarm is generated when the emission of the laser cannot reach the set value. Power alarm occurs only when the laser is emitting light.</p> <p>Solutions: Restart the Device. If this error continues to occur, please contact Raycus.</p>
ACDC1 Alarm	<p>Instruction: AC/DC1 Alarm. Laser power supply out of work or sudden power disconnect of the power supply system may cause the alarm.</p>

	<p>Solutions: Check whether the input AC voltage is normal. Restart the laser to try when it is normal. If the alarm continues to occur, please contact Raycus.</p>
<p>ACDC2 Alarm</p>	<p>Instruction: AC/DC2 Alarm. Overcurrent or overvoltage inside the device may cause this error.</p> <p>Solutions: Check whether the input AC voltage is normal. Restart the laser to try when it is normal. If the alarm continues to occur, please contact Raycus</p>
<p>T1/T2 Alarm</p>	<p>Instruction: Laser low / high temperature alarm occurs when the sensor in the laser detects that the internal temperature of the laser is abnormal. A high-temperature / low-temperature error occurs when the temperature at the monitoring point exceeds the set upper / lower limit.</p> <p>Solutions: High temperature alarm. Check whether the water-cooling system is normally working, the water temperature is set correctly, and also the water connection is correct. When the water cooling system works normally and the water temperature drops below 30°C, restart the laser. If the alarm continues, please contact Raycus.</p> <p>Low temperature alarm. Check whether the actual water temperature of the water is too low. In addition, a low ambient temperature may also cause a low temperature alarm when the laser is cold. Please wait until the water temperature of the water rises above 10°C and then restart the device. If the alarm continues, please contact Raycus</p>
<p>Hum Alarm</p>	<p>Instruction: The laser detects that the current temperature of the water-cooled plate is lower than the current dew point temperature of the laser. There is a risk of condensation.</p> <p>Solutions: Stop using the laser immediately. Please improve the working environment so that the ambient temperature is lower than the internal temperature, and then restart the laser (recommended to configure a separate air-conditioned room for the laser).If the alarm continues, please contact Raycus</p>

In addition to the above, if there are any other questions or errors, please contact Raycus to get help.

6 Warranty, Return and Maintenance

6.1 General Warranty

Raycus warrants that all Raycus fiber laser products are conformed to applicable product specifications under normal use and are free from defects in materials and workmanship.

The warranties start on the date of shipment from Raycus for a period of time as set forth in the applicable purchase contracts or product specifications. Raycus has the right to choose to repair or replace any product that proves to be defective in materials and workmanship selectively during the warranty period. Only products with particular defects are under warranty. Raycus reserves the right to issue a credit note for any defective products produced in normal conditions.

6.2 Limitations of Warranty

The warranty does not cover the maintenance or reimbursement of our product of which the problem results from tampering, disassembling, misuse, accident, modification, unsuitable physical or operating environment, improper maintenance, damages due to excessive use or not following the instructions caused by those who are not from Raycus. The customer has the responsibility to understand and follow this instruction to use the device. Any damage caused by fault operating is not warranted. Accessories and fiber connectors are excluded from this warranty.

According to the warranty, client should write to us within 31days after the defect is discovered. This warranty does not involve any other party, including specified buyer, end-user or customer and any parts, equipment or other products produced by other companies.



◆**WARNING:** It is the customer's responsibility to understand and follow operating instructions in this User Guide and specifications prior to operation-failure to do so may void this warranty. Accessories and fiber connectors are not covered by this warranty.

6.3 Service and Repair

- > Do not open the device. There are no user serviceable parts, equipment or assemblies for user in this product. All service and maintenance shall be performed by qualified Raycus personnel.
- > Please contact Raycus as soon as possible when problems under warranty about maintenance happened to the product.
- > The product returned with permission should be placed in a suitable container.
- > If any damage happened to the product, please notify the carrier in document immediately.

We reserve the right to make changes in design or constructions of any of our products at any time without incurring any obligation to make changes or install the same on units previously purchased.

All the items about warranty and service above provided by Raycus are for uses' reference; formal contents about warranty and service are subject to the contract.

© 2023 Wuhan Raycus Fiber Laser technologies Co. Ltd, All Rights Reserved